

Apex R6 seeria

autarco

Autarco Apex R6 paigaldussüsteem on kasvanud üheks kõige populaarsemaks päikesepaneelide paigaldussüsteemiks kaldkatustel. Tänu ainulaadsele konstruktsioonile on võimalik nutikas ja stabiilne ülikiire montaažiga konstruktsioon, tagades samal ajal päikesepaneelide optimaalse ja ohutu toetamise.

10

10-aastane tootegarantii



Kaldkatuse süsteem



Maastiku- või portreekinnitus on võimalik sama konksuga



Üks paigaldamiseks vajalik tööriist



Kerge, kuid vastupidav



KVALITEEDISERTIFIKAADID FÜSIKALISED OMADUSED

Rööpa seksioon (mm)

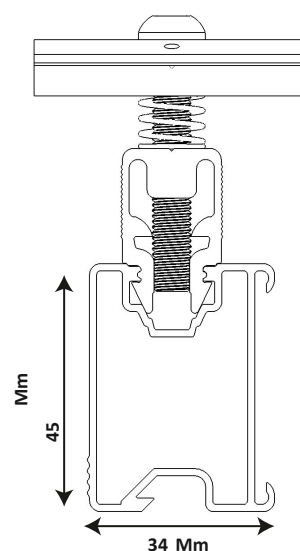

Maksimaalne katuse kalle	< 60°
Materjal	Alumiinium
Sobivad katusetüübid	Kõik kaldkatused, lainekatus, kivikatus (fikseeritud või reguleeritav)

ISO 9001, 14001, 18001 MCS012,



NEN7250



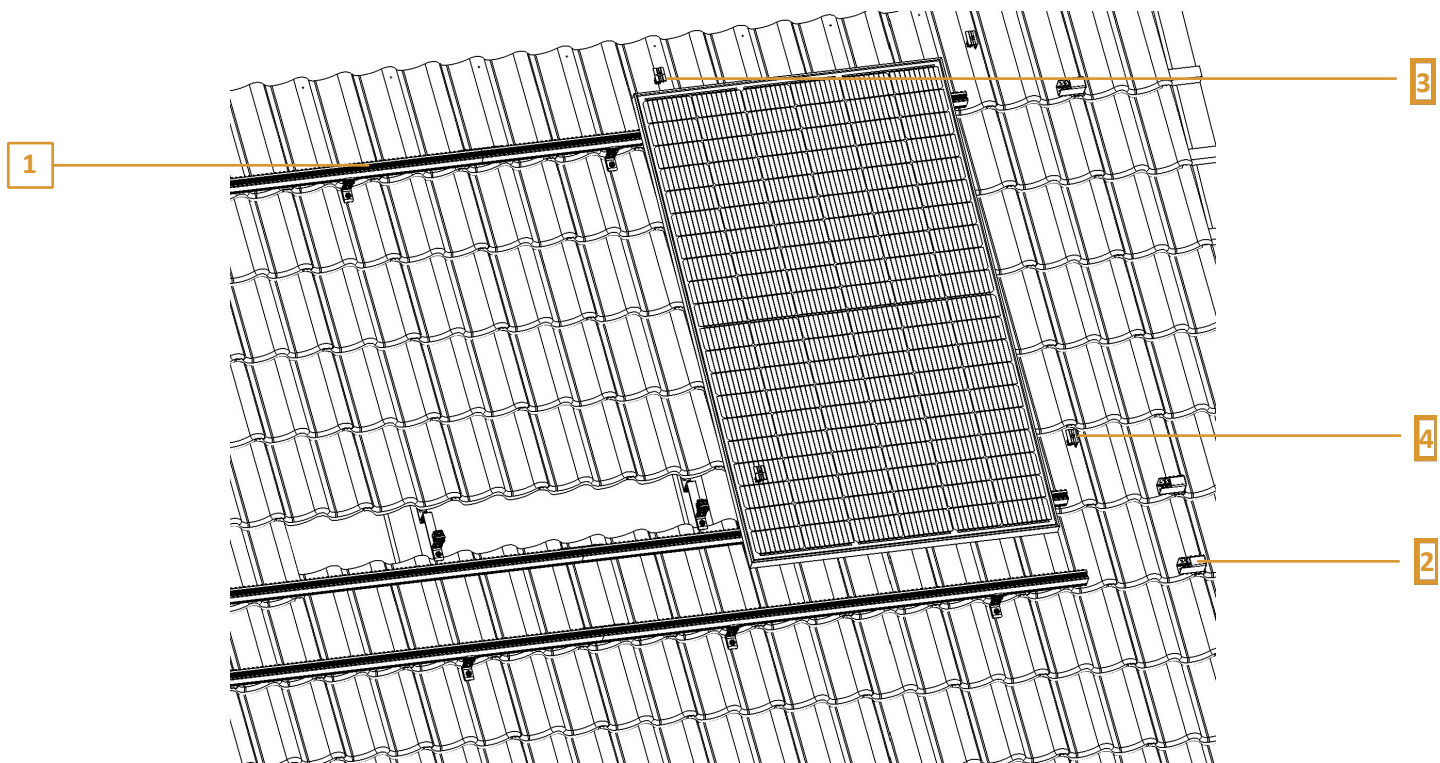

www.autarco.com





SÜSTEEMI KOMPONENDID

1	R6 rail	
	M1.AR6L3300.1 / 3580 / 4350 / 4730	
2	End cap	
	M1.AR6CAP.1	
	Splice connector	
	M1.AR6RJ.1	

KÜPSISED

3	Keskmine klamber	
	M1. AR6MC.1	
4	Otsaklamber	
	M1. AR6EC.1	

KONKSUD

Laineklipp	Reguleeritav alumiiniumkonks	Hangerbolt
 M2. AR6WC.1	 M2. AR6THX1,1	 m2. AR6HB.1

Selles andmelehes sisalduvad spetsifikatsioonid võivad käimasoleva tootearenduse tõttu meie tegelikest toodetest veidi erineda ja neid võidakse igal ajal ilma ette teatamata muuta.

